

Graze Elite Powercore

Date: _____

Type: _____

Firm Name: _____

Project: _____

100 to 277 VAC, 60° x 30°, 1224 mm (4 ft)

High-performance exterior linear grazing luminaire with white and color light

Graze Elite is a high-performance versatile exterior luminaire ideal for bright, even illumination of architectural details, façades, and surface textures. The latest Color Kinetics IntelliHue technology enables precision color-matching with millions of saturated colors, including red, amber, and purple—as well as exceptional white light. Graze Elite builds on the proven quality and reliability that the Graze family is known for, while delivering twice the output of previous generations while consuming less power. Its streamlined, rugged design protects it from the elements, ensuring years of hands-off operation.

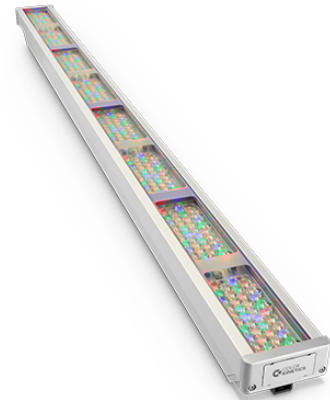

- High performance with less energy. Graze Elite provides twice the light output of current Graze luminaires, thanks to FluxBoost technology, which optimizes power and quality. And because it uses reliable, carefully selected mid-power LEDs, Graze Elite uses significantly less power than previous Graze luminaires.
- Versatile, high-quality output—color and white. The latest Color Kinetics IntelliHue technology enables the multi-channel Graze Elite (red, green, blue, amber, white) to output millions of saturated colors—as well as white light. Graze Elite outputs this wide gamut with exceptional accuracy (90+ CRI), including difficult-to-output colors, such as amber, purple, and magenta. And it outputs brilliant white light with high R9 values, exceeding the quality of white-only luminaires.
- Color consistency, no matter what. Chromasync Pro makes it easy to achieve color consistency with Graze Elite no matter what the LED mix, output, beam angle, or luminaire family. Simply choose three DMX values and let Chromasync Pro do the rest, even when combining luminaires using three, four, five, or more channels.
- Longer run lengths. The latest Powercore Pro technology enables longer run lengths of up to 400 feet, simplifying installations and reducing costs.
- Compatible with a wide range of controllers. Choose the controller that meets your needs, including iPlayer 4, iPlayer 3, Antumbra iColor Keypad, and ColorDial Pro—as well as third-party controllers.
- Advanced optics. Exceptional performance starts with Graze Elite's custom-designed optical system, which uses unique optics for each LED, customized based on its color. Its mid-power LEDs are carefully chosen using Color Kinetics Optibin technology and individually tested to ensure maximum quality and consistency.
- Reliability under punishing conditions. With its extruded aluminum body and tempered glass, Graze Elite's rugged design raises reliability and provides protection from corrosion. It meets the ASTM B117 and ANSI C136-31-2023 Roadway and Area Lighting for normal applications. Bridges and Overpass Protection Kit available.
- Beam angle options. Graze Elite is available in 6 standard beam angles 9° x 9°, NEW 10° x 15°, 10° x 60°, 15° x 30°, 30° x 60°, 60° x 30°.
- Fast, easy installation. Convenient push-and-click connectors let you easily and rapidly install leader cables and jumper cables. Constant torque locking hinges offer simple and consistent position control from various angles. Customize Graze Elite with mounting arms (three sizes) or other accessories.
- Sustainable design. Graze Elite is designed to be sustainable with a modular design, as well as being constructed with recyclable materials such as glass, and aluminum.

For detailed product information, please refer to the Graze Elite Product Guide at www.colorkinetics.com/global/products/intellihue/graze-elite

Specifications

Due to continuous improvements and innovations, specifications may change without notice.

Output

Beam Angle	60° x 30°
Lumens All Channels Full On †	3716
Lumens Max	5548
Lumens 2700 K	4432
Lumens 3000 K	4540
Lumens 4000 K	4572
Lumens 5700 K	4508
Lumens per channel	R 748 / G 2436 / B 436 / A 2572 / 4000K 3204
Efficacy (lm/W) full on †§	70.7
Efficacy (lm/W) 3000 K	86.7
Efficacy (lm/W) 4000 K	86.1
CRI @ 3000 K	94.3
CRI @ 4000 K	93.3
LED Channels	Red, Green, Blue, Amber, White 4000K

Electrical

Input Voltage	100 to 277 VAC, auto-ranging, 50/60 Hz
Power Consumption (Maximum at full output, steady state)	60 W
Power Factor	
Surge Limits ¶	6 kV maximum differential (L to N) 6 kV maximum common (L to Gnd or N to Gnd)

For additional Surge Protection Requirements for LED Lighting Systems, please refer to www.colorkinetics.com/KB/surge-protection.

Control

Interface	Data Enabler Pro gen3, DMX and Ethernet (KiNET and sACN)
Control Channels	3 channels per 6 in section w/ Chromasync Pro

For additional Control Channel information, please refer to <https://colorkinetics.helpdocs.io/article/fv5rpkvclq>.

Control System ‡

Works seamlessly with the Color Kinetics full range of controllers, including iPlayer 4, iPlayer 3, Antumbra iColor Keypad, and ColorDial Pro—as well as third-party controllers.

Remote Monitoring & Management Works with Interact Landmark

Lumen Maintenance

Threshold§	Ambient Temperature	Reported ¶¶	Calculated ¶¶¶
L ₉₀	25 °C	39,452	39,452
	50 °C	35,078	35,078
L ₈₀	25 °C	>54,000	81,872
	50 °C	>54,000	72,899
L ₇₀	25 °C	>54,000	>100,000
	50 °C	>54,000	>100,000
L ₅₀	25 °C	—	>100,000
	50 °C	—	>100,000

† 305 mm (1 ft) full on lumen output measurements comply with IES LM-79-08 testing procedures. All other measurements are estimated based on the 305 mm (1 ft) full on lumen measurements.

§ L_x = xx% lumen maintenance (when light output drops below xx% of initial output). All values are given at B10, or the median value where 90% of the LED population is better than the reported or calculated lumen maintenance measurement.

¶ Minimum surge limits per IEC 61547, tested in accordance with IEC 61000-4-5.

§§ Efficacy measurements are estimated based on the 305 mm (1 ft) full on measurements.

¶¶¶ Lumen maintenance figures are based on lifetime prediction graphs supplied by LED source manufacturers. Whenever possible, figures use measurements that comply with IES LM-80-08 testing procedures. In accordance with TM-21-11, Reported values represent the interpolated value based on six times the LM-80-08 total test duration (in hours). Calculated values represent time durations that exceed six times the total test duration.

Physical

Dimensions (Height x Width x Depth)	80 x 1224 x 84 mm (3.14 x 48.2 x 3.3 in)
Weight	7.0 kg (15.3 lb)
Housing Material	Extruded anodized aluminium
Lens	Tempered glass
Luminaire Connections	Integral male/female waterproof connectors
Mounting	Multi-positional, constant torque locking hinges

Temperature Ranges

-40 to 50 °C (-40 to 122 °F) Operating
 -20 to 50 °C (-4 to 122 °F) Startup
 -40 to 80 °C (-40 to 176 °F) Storage

Vibration Resistance

Complies with ANSI C136-31-2023 Roadway and Area Lighting for normal applications. Bridges and Overpass Protection Kit available.

Mechanical Impact IK07

Corrosion Resistance

Complies with ASTM B117 standard for > 1,500 hours. Please refer to www.colorkinetics.com/KB/corrosion-resistance for more information.

Humidity 0 to 95%, non-condensing

Thermal Protection enabled

For additional Thermal Protection information, please refer to <https://colorkinetics.helpdocs.io/article/sh301ducix>

Luminaire Run Lengths

To calculate luminaire run lengths and total power consumption for your specific installation, download the Configuration Calculator from www.colorkinetics.com/support/install_tool/

Certification and Safety

Approbation	UL/cUL, FCC Class B, CE
Environment	Dry/Damp/Wet Location, IP66

For additional Energy Efficiency Class Information, please refer to <https://colorkinetics.helpdocs.io/article/cvuis2p8qq>.



Dimensions

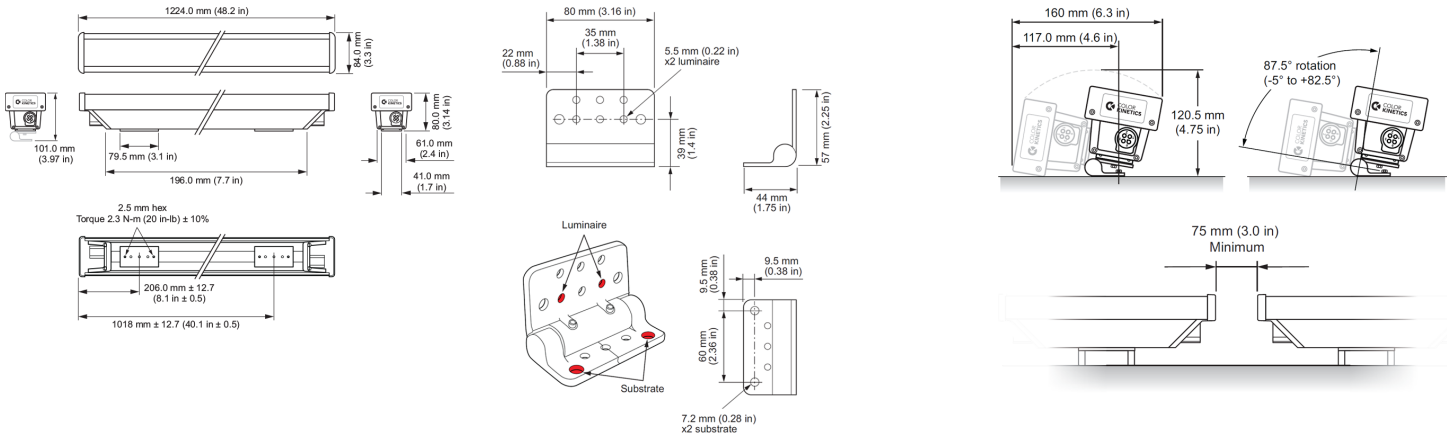

60° x 30° beam angle, 309 mm (1 ft), full on

Photometric data is based on test results from an independent NIST traceable testing lab. IES data is available at www.colorkinetics.com/global/support/ies.

Beam Angle	60° x 30°
LEDs	All Channels Full On
Lumens All Channels Full On	929.0
Efficacy (lm/W) full on	86.7

Illuminance at Distance

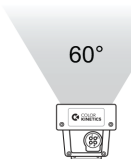

	Center Beam fc	Beam Width
4 ft	87.9 fc	2.3 ft 4.2 ft
8 ft	22.0 fc	4.7 ft 8.4 ft
12 ft	9.8 fc	7.0 ft 12.6 ft
16 ft	5.5 fc	9.3 ft 16.8 ft
20 ft	3.5 fc	11.6 ft 21.0 ft
24 ft	2.4 fc	14.0 ft 25.2 ft

Zonal Lumen

Zone	Lumens	% Luminaire
0-30	627.4	67.5%
0-40	779.9	83.9%
0-60	900.2	96.9%
60-90	29.0	3.1%
90-100	8.0	0.9%
90-120	0.0	0.0%
0-90	929.0	100.0%
90-180	0.0	0.0%
0-180	929.3	100.0%

9.3 m (30.5 ft) 1 fc maximum distance
 Vert. Spread: 32.5°
 Horiz. Spread: 55.4°

For lux multiply fc by 10.7

Coefficients of Utilization - Zonal Cavity Method

		Effective Floor Cavity Reflectance: 20%																	
RCC %:		70	80	0	70	50	30	20	50	30	20	10	0						
RW %:		70	50	30	0	70	50	30	0	50	30	20	0						
RCR:	0	1.19	1.19	1.19	1.19	1.16	1.16	1.16	1.00	1.11	1.11	1.11	1.06	1.06	1.06	1.02	1.02	1.02	1.00
	1	1.13	1.10	1.07	1.05	1.11	1.08	1.06	0.93	1.04	1.02	1.00	1.00	0.99	0.97	0.97	0.96	0.94	0.93
	2	1.07	1.02	0.98	0.94	1.05	1.00	0.96	0.86	0.97	0.94	0.91	0.94	0.91	0.89	0.91	0.89	0.87	0.85
	3	1.01	0.95	0.89	0.85	0.99	0.93	0.88	0.80	0.90	0.86	0.83	0.88	0.85	0.82	0.86	0.83	0.80	0.79
	4	0.95	0.88	0.82	0.78	0.94	0.87	0.81	0.74	0.85	0.80	0.76	0.83	0.79	0.75	0.81	0.77	0.75	0.73
	5	0.91	0.82	0.76	0.72	0.89	0.81	0.76	0.69	0.80	0.75	0.71	0.78	0.74	0.70	0.76	0.72	0.69	0.68
	6	0.86	0.77	0.71	0.67	0.85	0.76	0.71	0.65	0.75	0.70	0.66	0.73	0.69	0.65	0.72	0.68	0.65	0.63
	7	0.82	0.73	0.66	0.62	0.81	0.72	0.66	0.61	0.71	0.65	0.62	0.69	0.65	0.61	0.68	0.64	0.61	0.59
	8	0.78	0.69	0.62	0.58	0.77	0.68	0.62	0.57	0.67	0.62	0.58	0.66	0.61	0.58	0.65	0.61	0.57	0.56
	9	0.75	0.65	0.59	0.55	0.74	0.64	0.59	0.54	0.63	0.58	0.54	0.62	0.58	0.54	0.62	0.57	0.54	0.53
	10	0.71	0.62	0.56	0.52	0.70	0.61	0.55	0.51	0.60	0.55	0.52	0.59	0.55	0.51	0.59	0.54	0.51	0.50

Polar Candela Distribution

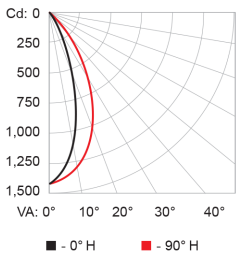

Cd:	0	25	45	70	90
0	1407	1407	1407	1407	1407
5	1343	1349	1360	1378	1381
15	823	874	932	1135	1180
25	346	395	515	743	840
35	134	155	217	354	433
45	63	70	88	135	169
55	38	39	42	56	66
65	21	21	21	22	24
75	8	7	7	6	6
85	1	1	1	1	1
90	0	0	0	0	0

60° x 30° beam angle, 309 mm (1 ft), 3000 K

Beam Angle	60° x 30°
LEDs at	3000 K
Lumens @ 3000 K	1135
Efficacy (lm/W) 3000 K	86.1

Illuminance at Distance

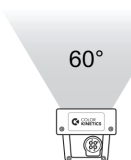

	Center Beam fc	Beam Width
4 ft	107.4 fc	2.3 ft 4.2 ft
8 ft	26.8 fc	4.7 ft 8.4 ft
12 ft	11.9 fc	7.0 ft 12.6 ft
16 ft	6.7 fc	9.3 ft 16.8 ft
20 ft	4.3 fc	11.6 ft 21.0 ft
24 ft	3.0 fc	14.0 ft 25.2 ft

Zonal Lumen

Zone	Lumens	% Luminaire
0-30	765.9	67.5%
0-40	952.1	83.9%
0-60	1099.0	96.9%
60-90	35.5	3.1%
90-100	7.0	0.9%
90-120	0.0	0.0%
0-90	1134.5	100.0%
90-180	0.0	0.0%
0-180	1134.5	100.0%

9.3 m (30.5 ft) 1 fc maximum distance
 Vert. Spread: 32.5°
 Horiz. Spread: 55.4°

For lux multiply fc by 10.7

Coefficients of Utilization - Zonal Cavity Method

		Effective Floor Cavity Reflectance: 20%																	
RCC %:		70	80	0	70	50	30	20	50	30	20	10	0						
RW %:		70	50	30	0	70	50	30	0	50	30	20	0						
RCR:	0	1.19	1.19	1.19	1.19	1.16	1.16	1.16	1.00	1.11	1.11	1.11	1.06	1.06	1.06	1.02	1.02	1.02	1.00
	1	1.13	1.10	1.07	1.05	1.11	1.08	1.06	0.93	1.04	1.02	1.00	1.00	0.99	0.97	0.97	0.96	0.94	0.93
	2	1.07	1.02	0.98	0.94	1.05	1.00	0.96	0.86	0.97	0.94	0.91	0.94	0.91	0.89	0.91	0.89	0.87	0.85
	3	1.01	0.95	0.89	0.85	0.99	0.93	0.88	0.80	0.90	0.86	0.83	0.88	0.85	0.82	0.86	0.83	0.80	0.79
	4	0.96	0.88	0.82	0.78	0.94	0.87	0.81	0.74	0.85	0.80	0.76	0.83	0.79	0.75	0.81	0.77	0.75	0.73
	5	0.91	0.82	0.76	0.72	0.89	0.81	0.76	0.69	0.80	0.75	0.71	0.78	0.74	0.70	0.76	0.72	0.69	0.68
	6	0.86	0.77	0.71	0.67	0.85	0.76	0.71	0.65	0.75	0.70	0.66	0.73	0.69	0.65	0.72	0.68	0.65	0.63
	7	0.82	0.73	0.66	0.62	0.81	0.72	0.66	0.61	0.71	0.65	0.62	0.69	0.65	0.61	0.68	0.64	0.61	0.59
	8	0.78	0.69	0.62	0.58	0.77	0.68	0.62	0.57	0.67	0.62	0.58	0.66	0.61	0.58	0.65	0.61	0.57	0.56
	9	0.75	0.65	0.59	0.55	0.74	0.64	0.59	0.54	0.63	0.58	0.54	0.62	0.58	0.54	0.62	0.57	0.54	0.53
	10	0.71	0.62	0.56	0.52	0.70	0.61	0.55	0.51	0.60	0.55	0.52	0.59	0.55	0.51	0.59	0.54	0.51	0.50

60° x 30° beam angle, 309 mm (1 ft), 4000 K

Photometric data is based on test results from an independent NIST traceable testing lab. IES data is available at www.colorkinetics.com/global/support/ies.

Beam Angle	60° x 30°
LEDs at	4000 K
Lumens @ 4000 K	1143
Efficacy (lm/W) 4000 K	86

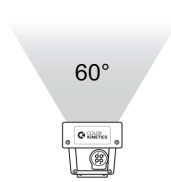

Illuminance at Distance

	Center Beam fc	Beam Width	
4 ft	108.1 fc	2.3 ft	4.2 ft
8 ft	27.0 fc	4.7 ft	8.4 ft
12 ft	12.0 fc	7.0 ft	12.6 ft
16 ft	6.8 fc	9.3 ft	16.8 ft
20 ft	4.3 fc	11.6 ft	21.0 ft
24 ft	3.0 fc	14.0 ft	25.2 ft

9.3 m (30.5 ft)
1 fc maximum distance

Vert. Spread: 32.5°
Horiz. Spread: 55.4°

Zonal Lumen

Zone	Lumens	% Luminaire
0-30	771.4	67.5%
0-40	958.9	83.9%
0-60	1106.8	96.9%
60-90	35.7	3.1%
70-100	9.9	0.9%
90-120	0.0	0.0%
0-90	1142.6	100.0%
90-180	0.0	0.0%
0-180	1142.6	100.0%

For lux multiply fc by 10.7

Polar Candela Distribution

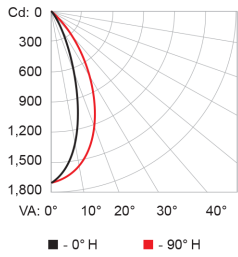

Cd: 0	0	25	45	70	90
0	1730	1730	1730	1730	1730
5	1651	1659	1672	1694	1698
15	1012	1075	1207	1395	1451
25	426	485	634	913	1033
35	165	191	267	435	533
45	78	86	108	166	208
55	47	47	51	68	81
65	26	25	26	27	30
75	10	9	8	7	7
85	1	1	1	1	1
90	0	0	0	0	0

Coefficients of Utilization - Zonal Cavity Method

RCC %:	Effective Floor Cavity Reflectance: 20%																			
	80				70				50				30				10			
RW %:	70	50	30	0	70	50	30	0	50	30	20	50	30	20	50	30	20	0		
RCR:	0	1.19	1.19	1.19	1.16	1.16	1.16	1.00	1.11	1.11	1.11	1.06	1.06	1.06	1.02	1.02	1.02	1.00		
1	1.13	1.10	1.07	1.05	1.11	1.08	1.06	0.93	1.04	1.02	1.00	1.00	0.99	0.97	0.97	0.96	0.94	0.93		
2	1.07	1.02	0.98	0.94	1.05	1.00	0.96	0.86	0.97	0.94	0.91	0.94	0.91	0.89	0.91	0.89	0.87	0.85		
3	1.01	0.95	0.89	0.85	0.99	0.93	0.88	0.80	0.90	0.86	0.83	0.88	0.85	0.82	0.86	0.83	0.80	0.79		
4	0.96	0.88	0.82	0.78	0.94	0.87	0.81	0.74	0.85	0.80	0.76	0.83	0.79	0.75	0.81	0.77	0.75	0.73		
5	0.91	0.82	0.76	0.72	0.89	0.81	0.76	0.69	0.80	0.75	0.71	0.78	0.74	0.70	0.76	0.72	0.69	0.68		
6	0.86	0.77	0.71	0.67	0.85	0.76	0.71	0.65	0.75	0.70	0.66	0.73	0.69	0.65	0.72	0.68	0.65	0.63		
7	0.82	0.73	0.66	0.62	0.81	0.72	0.66	0.61	0.71	0.65	0.62	0.69	0.65	0.61	0.68	0.64	0.61	0.59		
8	0.78	0.69	0.62	0.58	0.77	0.68	0.62	0.57	0.67	0.62	0.58	0.66	0.61	0.58	0.65	0.61	0.57	0.56		
9	0.75	0.65	0.59	0.55	0.74	0.64	0.59	0.54	0.63	0.58	0.54	0.62	0.58	0.54	0.62	0.57	0.54	0.53		
10	0.71	0.62	0.56	0.52	0.70	0.61	0.55	0.51	0.60	0.55	0.52	0.59	0.55	0.51	0.59	0.54	0.51	0.50		

Luminaire and Accessories

Use Item Number when ordering in North America

Luminaire	Item Number	Item 12NC
Graze Elite Powercore, 100 to 277 VAC, 60° x 30°, 1224 mm (4 ft)	623-000001-12	912400138132
Accessories		
Graze Elite Glare Shield Kit, 1225 mm (4 ft), Gray	623-000006-03	912400138163
Graze Elite Masking Shield Kit, 1225 mm (4 ft), Gray	623-000006-05	912400138165
Graze Elite Louver Kit, 1225 mm (4 ft), Gray	623-000006-07	912400138167
Architectural Mounting Arm, for use with Blast, Graze Elite, Graze, Graze Compact, Burst Architectural. Short, gray	120-000206-00	912400136642
Architectural Mounting Arm, for use with Blast, Graze Elite, Graze, Graze Compact, Burst Architectural. Medium, gray	120-000206-01	912400136643
Architectural Mounting Arm, for use with Blast, Graze Elite, Graze, Graze Compact, Burst Architectural. Long, gray	120-000206-02	912400136644
4 Conductor Leader Cable, For use with Graze Powercore, ReachElite, 100 to 277 VAC, 15.2 m (50 ft), Black, UL	108-000055-00	910503703137
4 Conductor Leader Cable, For use with Graze Powercore, ReachElite, 100 to 277 VAC, 15.2 m (50 ft), Black, CE/PSE	108-000055-01	910503704064
4 Conductor Leader Cable, For use with Graze Powercore, ReachElite, 100 to 277 VAC, 3 m (10 ft), Black, UL	108-000055-03	910503704066
4 Conductor Leader Cable, For use with Graze Powercore, ReachElite, 100 to 277 VAC, 3 m (10 ft), Black, CE/PSE	108-000055-04	910503704067
4 Conductor Leader Cable, For use with Graze Powercore, ReachElite, 3 m (10 ft), Black, CE/PSE	108-000055-07	910503705065
4 Conductor Leader Cable, For use with Graze Powercore luminaires, 1.52 m (5 ft), UL, for Inground Enclosure	108-000055-09	912400134321
4 Conductor Leader Cable, For use with Graze Powercore luminaires, 1.52 m (5 ft), CE, for Inground Enclosure	108-000055-10	912400134322
4 Conductor Leader Cable, For use with Graze Powercore, ReachElite, 100 to 277 VAC, 3 m (10 ft), BIS	108-000055-13	912400137373
4 Conductor Jumper Cable, For use with Graze MX/QLX/EC luminaires, End-to-End, Black, UL/cUL	108-000057-00	910503703139
4 Conductor Jumper Cable, For use with Graze MX/QLX/EC luminaires, End-to-End, Black, CE/PSE	108-000057-01	910503704074
4 Conductor Jumper Cable, For use with Graze MX/QLX/EC luminaires, 305 mm (1 ft), Black, UL/cUL	108-000057-03	910503704076
4 Conductor Jumper Cable, For use with Graze MX/QLX/EC luminaires, 305 mm (1 ft), Black, CE/PSE	108-000057-04	910503704077
4 Conductor Jumper Cable, For use with Graze MX/QLX/EC luminaires, 1.5 m (5 ft), Black, UL/cUL	108-000057-06	910503704079
4 Conductor Jumper Cable, For use with Graze MX/QLX/EC luminaires, 1.5 m (5 ft), Black, CE/PSE	108-000057-07	910503704080
4 Conductor Jumper Cable, For use with Graze MX/QLX/EC luminaires, End-to-End, Black, BIS	108-000057-18	912400137377
4 Conductor Jumper Cable, For use with Graze MX/QLX/EC luminaires, 1.5 m (5 ft), Black, BIS	108-000057-19	912400137378
Power Supplies		
Data Enabler Pro gen3, 3/4 in / 1/2 in NPT (U.S. trade size conduit) 100 to 277 VAC, UL	106-000004-04	912400138114
Data Enabler Pro gen3, M25 / M20 (metric size conduit) 100 to 240 VAC, CE	106-000004-05	912400138115

