

BlastElite Powercore

Date: _____

Type: _____

Firm Name: _____

Project: _____

100 to 277 VAC, 10° Native (no spread lens), Gray Housing

High-performance versatile and customizable exterior luminaire with white and color light

The benefits of Blast, now Elite. Powered by FluxBoost technology, BlastElite delivers higher light output while using less energy, thanks to efficient mid-power LEDs. IntelliHue provides versatile, high-quality light output, offering millions of saturated colors and brilliant white light with exceptional CRI and R9 values. Chromasync ensures consistent color from luminaire to luminaire, while Powercore enables longer run lengths up to 400 feet. Custom optics, flexible pixel settings, rugged reliability, and compatibility with a wide range of controllers make BlastElite versatile for diverse applications. A wide variety of accessories offer flexibility in any application.



- High performance with less energy. BlastElite provides more light output compared to current Blast luminaires, thanks to FluxBoost technology, which optimizes power and light output. And because it uses reliable, carefully selected mid-power LEDs, BlastElite uses significantly less power than previous Blast luminaires.
 - Versatile, high-quality output—color and white. The latest Color Kinetics IntelliHue technology enables the multi-channel BlastElite (red, green, blue, amber, white) to output millions of saturated colors—as well as white light. BlastElite outputs this wide gamut with exceptional accuracy (91+ CRI), including difficult-to-output colors, such as amber, purple, and magenta. And it outputs brilliant white light with high R9 values, exceeding the quality of white-only luminaires.
 - Color consistency, no matter what. Chromasync Pro makes it easy to achieve color consistency with BlastElite no matter what the LED mix, output, beam angle, or luminaire family. Simply choose three DMX values and let Chromasync Pro do the rest, even when combining luminaires using three, four, five, or more channels.
 - Advanced optics. Exceptional performance starts with BlastElite's custom-designed optical system, which uses unique optics for each LED, customized based on its colors. Its mid-power LEDs are carefully chosen using Color Kinetics Optibin technology and individually tested to ensure maximum quality and consistency.
 - Longer run lengths. The latest Powercore technology enables longer run lengths of up to 400 feet, simplifying installations and reducing costs.
 - Flexible Pixel. BlastElite is factory set at one pixel just like current Blast, but BlastElite can be easily changed to display 1, 2, or 4 individual pixels for direct-view applications.
 - Reliability under punishing conditions. With its die-cast aluminum body and tempered glass, BlastElite's rugged design raises reliability and provides protection from the elements. It offers 6 kV surge protection, and meets the ASTM B117 standard > 1,500 hours, and ANSI C136-31-2023 Roadway and Area Lighting for Bridges and Overpasses.
 - Compatible with a wide range of controllers. Choose the controller that meets your needs, including iPlayer 4, iPlayer 3, Antumbra iColor Keypad, and ColorDial Pro—as well as third-party controllers.
 - Expands customization with a wide range of accessory options. In addition to the native 10° lens, five different spread lenses can customize the luminaire to produce 20°, 40°, 60°, 80°, and 10° x 40° (asymmetric) beam angles. All accessories match housing color options (black, gray, and white) – including adding or combining a spread lens, rock guard, and full or half glare shield.
- For detailed product information, please refer to the BlastElite Product Guide at www.colorkinetics.com/global/products/intellihue/blastelite

Specifications

Due to continuous improvements and innovations, specifications may change without notice.

Output

Beam Angle	10°
Lumens All Channels Full On †	2064
Lumens Max *	2783
Lumens 2700 K *	2427
Lumens 3000 K *	2476
Lumens 4000 K *	2495
Lumens 5000 K *	2476
Lumens per channel *	R 433 / G 1,344 / B 216 / A 1,330 / 4000K 1,710
Efficacy (lm/W) full on	78.6
Efficacy (lm/W) 3000 K	94.9
Efficacy (lm/W) 4000 K	95.5
CRI @ 3000 K	92.9
CRI @ 4000 K	91.7
LED Channels	Red, Green, Blue, Amber, White 4000K

Electrical

Input Voltage	100 to 277 VAC, auto-ranging, 50/60 Hz
Power Consumption (Maximum at full output, steady state)	30 W
Power Factor	0.99 @ 120 VAC
Surge Limits ¶	6 kV maximum differential (L to N) 6 kV maximum common (L to Gnd or N to Gnd)

For additional Surge Protection Requirements for LED Lighting Systems, please refer to www.colorkinetics.com/KB/surge-protection

Control

Interface	Data Enabler Pro (DMX or Ethernet)
Control Channels	3 channels per pixel with Chromasync Pro (default), or 5 channels per pixel. 1, 2, or 4 pixels per luminaire; pixel order and count configurable with QPP2. 8-bit input (default); 16-bit input capable (requires 2x DMX channels). For additional Control Channel information, please refer to https://colorkinetics.helpdocs.io/article/fv5rkvclq .
Control System ‡	Color Kinetics full range of controllers, including iPlayer 3, iPlayer 4, Antumbra iColor Keypad, and ColorDial Pro, or third-party controllers. Remote Monitoring & Management Works with Interact Landmark

Lumen Maintenance

Threshold§	Ambient Temperature	Reported ¶¶	Calculated ¶¶
L ₉₀	25 °C	39,452	39,452
	50 °C	35,078	35,078
L ₈₀	25 °C	>54,000	81,872
	50 °C	>54,000	72,899
L ₇₀	25 °C	>54,000	>100,000
	50 °C	>54,000	>100,000
L ₅₀	25 °C	-	>100,000
	50 °C	-	>100,000

* Correlated color temperature (CCT) complies with ANSI C78.377-2008 for the chromaticity of solid state lighting products.

† Full-on lumen output measurements comply with IES LM-79-08 testing procedures. All other measurements are estimated based on the full-on measurements.

§ L_{xx} = xx% lumen maintenance (when light output drops below xx% of initial output). All values are given at B10, or the median value where 90% of the LED population is better than the reported or calculated lumen maintenance measurement.

¶ Minimum surge limits per IEC 61547, tested in accordance with IEC 61000-4-5.

†† When mounting to a junction box, the Color Kinetics wiring compartment accessory must be used to maintain a 3G vibration rating.

¶¶ Lumen maintenance figures are based on lifetime prediction graphs supplied by LED source manufacturers. Whenever possible, figures use measurements that comply with IES LM-80-08 testing procedures. In accordance with TM-21-11, Reported values represent the interpolated value based on six times the LM-80-08 total test duration (in hours). Calculated values represent time durations that exceed six times the total test duration.

Physical

Dimensions (Height x Width x Depth)	181.0 x 339.0 x 184.0 mm (7.1 x 13.4 x 7.3 in)
Weight	4.9 kg (10.8 lb)
Effective Projected Area (EPA)	0.068 m ² (0.73 ft ²) (Luminaire plus Full Glare Shield)
Housing Material	Die-cast aluminium, powder-coated finish
Lens	Clear tempered glass
Luminaire Connections	1.8 m (6 ft) unified power/data cable

Temperature Ranges

-40 to 50 °C (-40 to 122 °F) Operating
-20 to 50 °C (-4 to 122 °F) Startup
-40 to 80 °C (-40 to 176 °F) Storage

Vibration Resistance

Complies with ANSI C136-31-2023 Roadway and Area Lighting for Bridges and Overpasses.

Mechanical Impact	IK10
-------------------	------

Corrosion Resistance

Complies with ASTM B117 standard for > 1,500 hours

Humidity	0 to 95%, non-condensing
----------	--------------------------

Thermal Protection enabled

For additional Thermal Protection information, please refer to <https://colorkinetics.helpdocs.io/article/sh301ducix>

Luminaire Run Lengths

To calculate luminaire run lengths and total power consumption for your specific installation, download the Configuration Calculator from www.colorkinetics.com/support/install_tool/

Certification and Safety

Approbation	UL/cUL, FCC Class B, CE, PSE, C-Tick
Environment	Dry/Damp/Wet Location, IP66

For additional Energy Efficiency Class Information, please refer to <https://colorkinetics.helpdocs.io/article/cvuis2p8qq>.



Dimensions

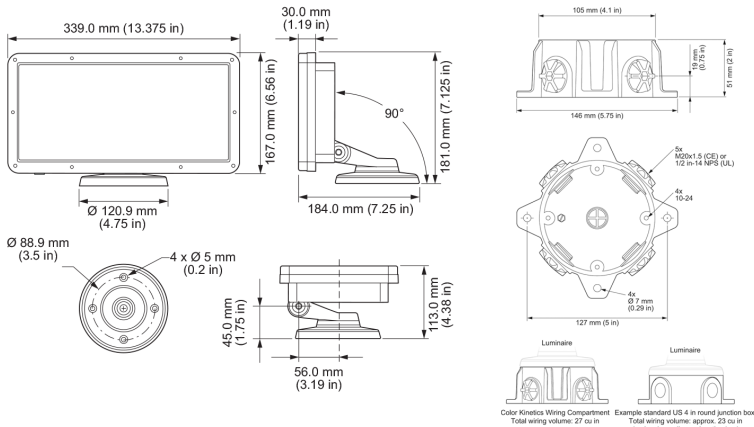

Photometrics Full on

Photometric data is based on test results from an independent NIST traceable testing lab. IES data is available at www.colorkinetics.com/global/support/ies.

Beam Angle	10°
LEDs	All Channels Full On
Lumens All Channels Full On	2,064.0
Efficacy (lm/W) full on	78.6

Illuminance at Distance

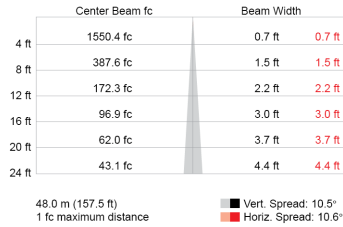

Zonal Lumen

Zone	Lumens	% Luminaire
0-30	1805.8	88.1%
0-40	1891.6	92.3%
0-60	1996.1	97.4%
60-90	53.3	2.6%
70-100	18.6	0.9%
90-120	0.0	0.0%
0-90	2049.4	100.0%
90-180	0.0	0.0%
0-180	2049.4	100.0%

For lux multiply fc by 10.7

Polar Candela Distribution

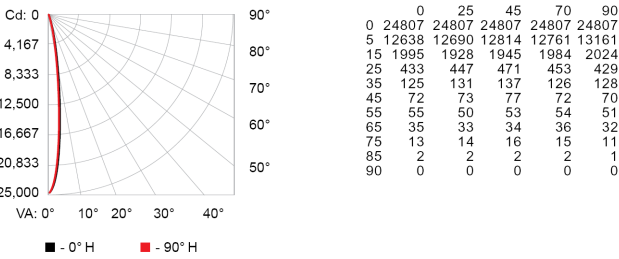

Coefficients of Utilization - Zonal Cavity Method

RCC %:	Effective Floor Cavity Reflectance: 20%															
	70	80	0	70	50	30	20	50	30	20	10	0				
RW %:	70	50	30	0	70	50	30	0	50	30	20	50	30	20	10	0
RCR:	0	1.19	1.19	1.19	1.16	1.16	1.16	1.00	1.11	1.11	1.11	1.06	1.06	1.06	1.02	1.02
1	1.15	1.12	1.10	1.09	1.12	1.10	1.09	0.96	1.06	1.05	1.04	1.03	1.02	1.01	0.99	0.98
2	1.11	1.07	1.04	1.01	1.09	1.05	1.02	0.93	1.02	1.00	0.98	0.99	0.97	0.96	0.96	0.95
3	1.07	1.02	0.98	0.95	1.05	1.01	0.97	0.90	0.98	0.95	0.93	0.96	0.94	0.92	0.94	0.92
4	1.04	0.98	0.94	0.91	1.02	0.97	0.93	0.87	0.95	0.92	0.89	0.93	0.90	0.88	0.91	0.89
5	1.01	0.95	0.90	0.87	0.99	0.94	0.90	0.84	0.92	0.89	0.86	0.91	0.88	0.85	0.89	0.87
6	0.98	0.92	0.87	0.84	0.97	0.91	0.87	0.82	0.90	0.86	0.83	0.88	0.85	0.83	0.87	0.84
7	0.95	0.89	0.85	0.82	0.94	0.88	0.84	0.80	0.87	0.84	0.81	0.86	0.83	0.81	0.85	0.82
8	0.93	0.86	0.82	0.80	0.92	0.86	0.82	0.78	0.85	0.82	0.79	0.84	0.81	0.79	0.83	0.81
9	0.91	0.84	0.80	0.78	0.90	0.84	0.80	0.77	0.83	0.80	0.77	0.82	0.79	0.77	0.82	0.79
10	0.89	0.82	0.78	0.76	0.88	0.82	0.78	0.75	0.81	0.78	0.76	0.81	0.78	0.75	0.80	0.77

Photometrics 3000 K

Beam Angle	10°
LEDs at	3000 K
Lumens @ 3000 K	2476
Efficacy (lm/W) 3000 K	94.9

Illuminance at Distance

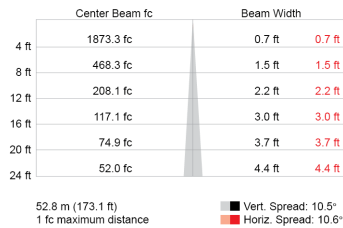

Zonal Lumen

Zone	Lumens	% Luminaire
0-30	2181.9	88.1%
0-40	2285.6	92.3%
0-60	2411.8	97.4%
60-90	64.4	2.6%
70-100	22.5	0.9%
90-120	0.0	0.0%
0-90	2476.3	100.0%
90-180	0.0	0.0%
0-180	2476.3	100.0%

For lux multiply fc by 10.7

Polar Candela Distribution

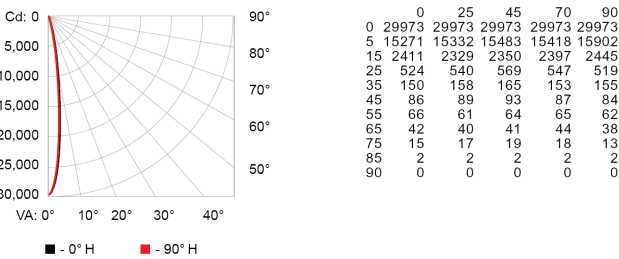

Coefficients of Utilization - Zonal Cavity Method

RCC %:	Effective Floor Cavity Reflectance: 20%															
	70	80	0	70	50	30	20	50	30	20	10	0				
RW %:	70	50	30	0	70	50	30	0	50	30	20	50	30	20	10	0
RCR:	0	1.19	1.19	1.19	1.16	1.16	1.16	1.00	1.11	1.11	1.11	1.06	1.06	1.06	1.02	1.02
1	1.15	1.12	1.10	1.09	1.12	1.10	1.09	0.96	1.06	1.05	1.04	1.03	1.02	1.01	0.99	0.98
2	1.11	1.07	1.04	1.01	1.09	1.05	1.02	0.93	1.02	1.00	0.98	0.99	0.97	0.96	0.96	0.95
3	1.07	1.02	0.98	0.95	1.05	1.01	0.97	0.90	0.98	0.95	0.93	0.96	0.94	0.92	0.94	0.92
4	1.04	0.98	0.94	0.91	1.02	0.97	0.93	0.87	0.95	0.92	0.89	0.93	0.90	0.88	0.91	0.89
5	1.01	0.95	0.90	0.87	0.99	0.94	0.90	0.84	0.92	0.89	0.86	0.91	0.88	0.85	0.89	0.87
6	0.98	0.92	0.87	0.84	0.97	0.91	0.87	0.82	0.90	0.86	0.83	0.88	0.85	0.83	0.87	0.84
7	0.95	0.89	0.85	0.82	0.94	0.88	0.84	0.80	0.87	0.84	0.81	0.86	0.83	0.81	0.85	0.82
8	0.93	0.86	0.82	0.80	0.92	0.86	0.82	0.78	0.85	0.82	0.79	0.84	0.81	0.79	0.83	0.81
9	0.91	0.84	0.80	0.78	0.90	0.84	0.80	0.77	0.83	0.80	0.77	0.82	0.79	0.77	0.82	0.79
10	0.89	0.82	0.78	0.76	0.88	0.82	0.78	0.75	0.81	0.78	0.76	0.81	0.78	0.75	0.80	0.77

Photometrics 4000 K

Photometric data is based on test results from an independent NIST traceable testing lab. IES data is available at www.colorkinetics.com/global/support/ies.

Beam Angle	10°
LEDs at	4000 K
Lumens @ 4000 K	2495
Efficacy (lm/W) 4000 K	95.5

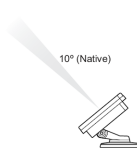

Illuminance at Distance

	Center Beam fc	Beam Width
4 ft	18879 fc	0.7 ft 0.7 ft
8 ft	472.0 fc	1.5 ft 1.5 ft
12 ft	209.8 fc	2.2 ft 2.2 ft
16 ft	118.0 fc	3.0 ft 3.0 ft
20 ft	75.5 fc	3.7 ft 3.7 ft
24 ft	52.4 fc	4.4 ft 4.4 ft

53 m (173.8 ft)
1 fc maximum distance

Vert. Spread: 10.5°
Horiz. Spread: 10.6°

Zonal Lumen

Zone	Lumens	% Luminaire
0-30	2198.9	88.1%
0-40	2303.4	92.3%
0-60	2430.6	97.4%
60-90	65.0	2.6%
70-100	22.6	0.9%
90-120	0.0	0.0%
0-90	2495.6	100.0%
90-180	0.0	0.0%
0-180	2495.6	100.0%

For lux multiply fc by 10.7

Polar Candela Distribution

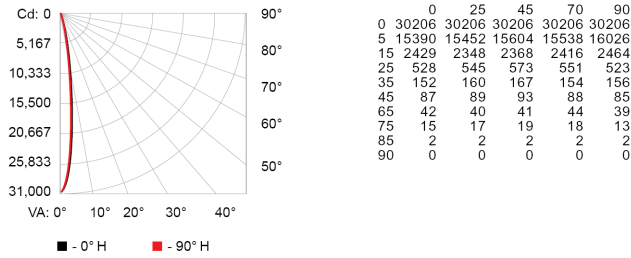

Coefficients of Utilization - Zonal Cavity Method

Effective Floor Cavity Reflectance: 20%

RCC %:	80				70				50				30				10				0
RW %:	70	50	30	0	70	50	30	0	50	30	20	50	30	20	50	30	20	50	30	20	0
RCR:	0	1.19	1.19	1.19	1.16	1.16	1.16	1.00	1.11	1.11	1.11	1.06	1.06	1.06	1.02	1.02	1.02	1.00	1.00	1.00	1.00
	1	1.15	1.12	1.10	1.09	1.12	1.10	1.09	0.96	1.06	1.05	1.04	1.03	1.02	1.01	0.99	0.98	0.96	0.96	0.96	0.96
	2	1.11	1.07	1.04	1.01	1.09	1.05	1.02	0.93	1.02	1.00	0.98	0.99	0.97	0.96	0.96	0.95	0.94	0.92	0.90	0.89
	3	1.07	1.02	0.98	0.95	1.05	1.01	0.97	0.90	0.98	0.95	0.93	0.96	0.94	0.92	0.94	0.92	0.90	0.88	0.87	0.86
	4	1.04	0.98	0.94	0.91	1.02	0.97	0.93	0.87	0.95	0.92	0.89	0.93	0.90	0.88	0.91	0.89	0.87	0.85	0.84	0.84
	5	1.01	0.95	0.90	0.87	0.99	0.94	0.90	0.84	0.92	0.89	0.86	0.91	0.88	0.85	0.89	0.87	0.85	0.84	0.84	0.84
	6	0.98	0.92	0.87	0.84	0.97	0.91	0.87	0.82	0.90	0.86	0.83	0.88	0.85	0.83	0.87	0.84	0.82	0.81	0.81	0.81
	7	0.95	0.89	0.85	0.82	0.94	0.88	0.84	0.80	0.87	0.84	0.81	0.86	0.83	0.81	0.85	0.82	0.80	0.79	0.79	0.79
	8	0.93	0.86	0.82	0.80	0.92	0.86	0.82	0.78	0.85	0.82	0.79	0.84	0.81	0.79	0.83	0.81	0.78	0.78	0.78	0.78
	9	0.91	0.84	0.80	0.78	0.90	0.84	0.80	0.77	0.83	0.80	0.77	0.82	0.79	0.77	0.82	0.79	0.77	0.76	0.76	0.76
	10	0.89	0.82	0.78	0.76	0.88	0.82	0.78	0.75	0.81	0.78	0.76	0.81	0.78	0.75	0.80	0.77	0.75	0.74	0.74	0.74

Luminaire and Accessories

Use Item Number when ordering in North America

Luminaire	Item Number	Item 12NC
BlastElite Powercore, 100 to 277 VAC, 10° Native (no spread lens), Gray Housing BCP681 100-277V 10 GR	623-000101-03	912400138483
Accessories		
Trim Ring, Gray	120-000185-15	912400133530
Rock Guard, Gray	120-000185-18	912400133533
Half Glare Shield, Gray	120-000185-19	912400133534
Full Glare Shield, Gray	120-000185-16	912400133531
20° Spread lens	120-000185-08	912400130344
40° Spread lens	120-000185-09	912400130345
60° Spread lens	120-000185-10	912400130346
80° Spread lens	120-000185-11	912400130347
10°x40° Spread lens	120-000185-12	912400130348
Wiring Compartment UL/cUL, Black	106-000011-30	910503704147
Wiring Compartment CE, Black	106-000011-40	910503703275
Architectural Mounting Arm, for use with BlastElite, Blast, Graze, Graze Compact, and Burst Architectural. Short, gray	120-000206-00	912400136642
Architectural Mounting Arm, for use with BlastElite, Blast, Graze, Graze Compact, and Burst Architectural. Medium, gray	120-000206-01	912400136643
Architectural Mounting Arm, for use with BlastElite, Blast, Graze, Graze Compact, and Burst Architectural. Long, gray	120-000206-02	912400136644
Power Supplies		
Data Enabler Pro gen3, 3/4 in / 1/2 in NPT (U.S. trade size conduit)	106-000004-04	912400138114
Data Enabler Pro gen3, PG21/PG13 (metric size conduit)	106-000004-05	912400138115



© 2025 Signify Holding. All rights reserved. Specifications are subject to change without notice. No representation or warranty as to the accuracy or completeness of the information included herein is given and any liability for any action in reliance thereon is disclaimed.

Color Kinetics
www.colorkinetics.com/global/products/intellihue/blastelite